

# RM-NC / GRM-NC

Servo stamping and forming machines

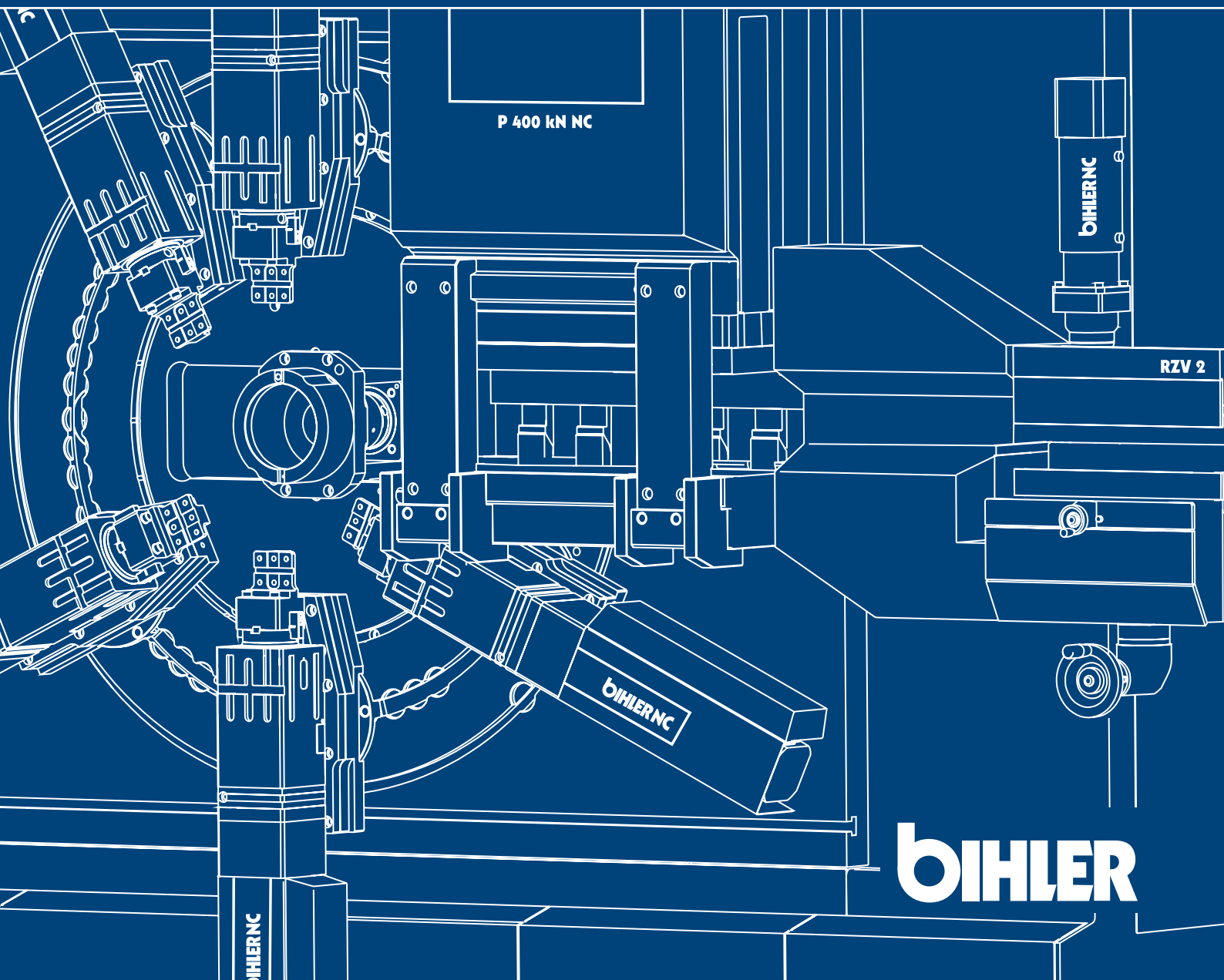

**BIHLER**



### The world's fastest servo stamping and forming machines

Increase the efficiency in your production. With the servo stamping and forming machines RM-NC and GRM-NC you manufacture a wide spectrum of classical stamped and formed parts as well as wire parts more flexible and productive.

Benefit from very fast tool changes, flexible handling of even smallest batch sizes as well as constantly high production quality. Full tool compatibility with machines in the RM and GRM series opens up unbeatable prospects regarding increase in output and shortest change-over times.



# RM-NC

Highlights

## The highlights at a glance

- Highly efficient production of stamped and formed parts as well as wire parts even in smallest batch sizes
- High production speeds up to 300 1/min.
- Rapid response to short-term customer requests
- Convenient operation with VariControl VC 1
- Full tool compatibility with RM series
- Decisive increase in output (more than 300% possible\*)
- Extremely short set-up times (up to 9 times faster\*)



\*Production tests: Moving tools from mechanical machine types to servo-controlled machine + optimization

# GRM-NC

Highlights

## The highlights at a glance

- Highly efficient production of stamped and formed parts as well as wire parts even in smallest batch sizes
- High production speeds up to 240 1/min.
- Rapid response to short-term customer requests
- Significant reduction in tool costs
- Full tool compatibility with GRM series
- Lot sizes can be processed in half time\*
- Extremely short set-up times (up to 9 times faster\*)

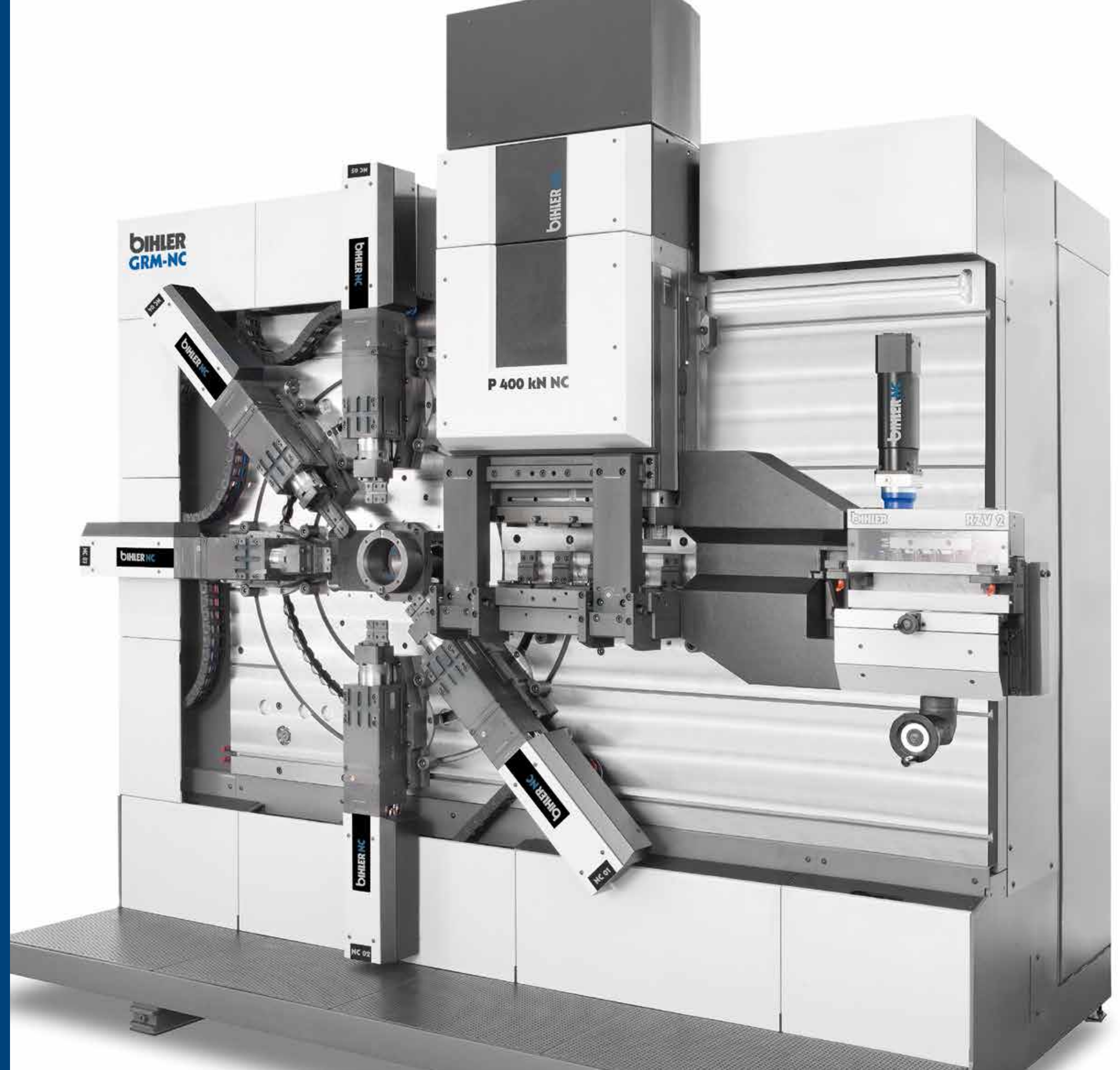

\*Production tests: Moving tools from mechanical machine types to servo-controlled machine + optimization



# RM-NC / GRM-NC

At a glance

Fully automatic alignment and positioning in radial and linear direction

Freely programmable:  
Working stroke  
BDC  
Adjustable stroke position  
Motion profile

Easy handling

Integrated absolute travel measuring system

No fixed stop on tools

All interfaces available to RM and GRM series

Up to 3-fold central dies

Integrated slide alignment and positioning unit

Radial and linear tool concept

Controller and actuator integrated in machine casing

Integrated overload protection for NC components

Integrated press force and bearing temperature monitoring

Freely programmable (friction press):  
Working stroke  
BDC  
Adjustable stroke position  
Motion profile

Freely programmable:  
Feeder length

Universal press plate for integration of existing die tools

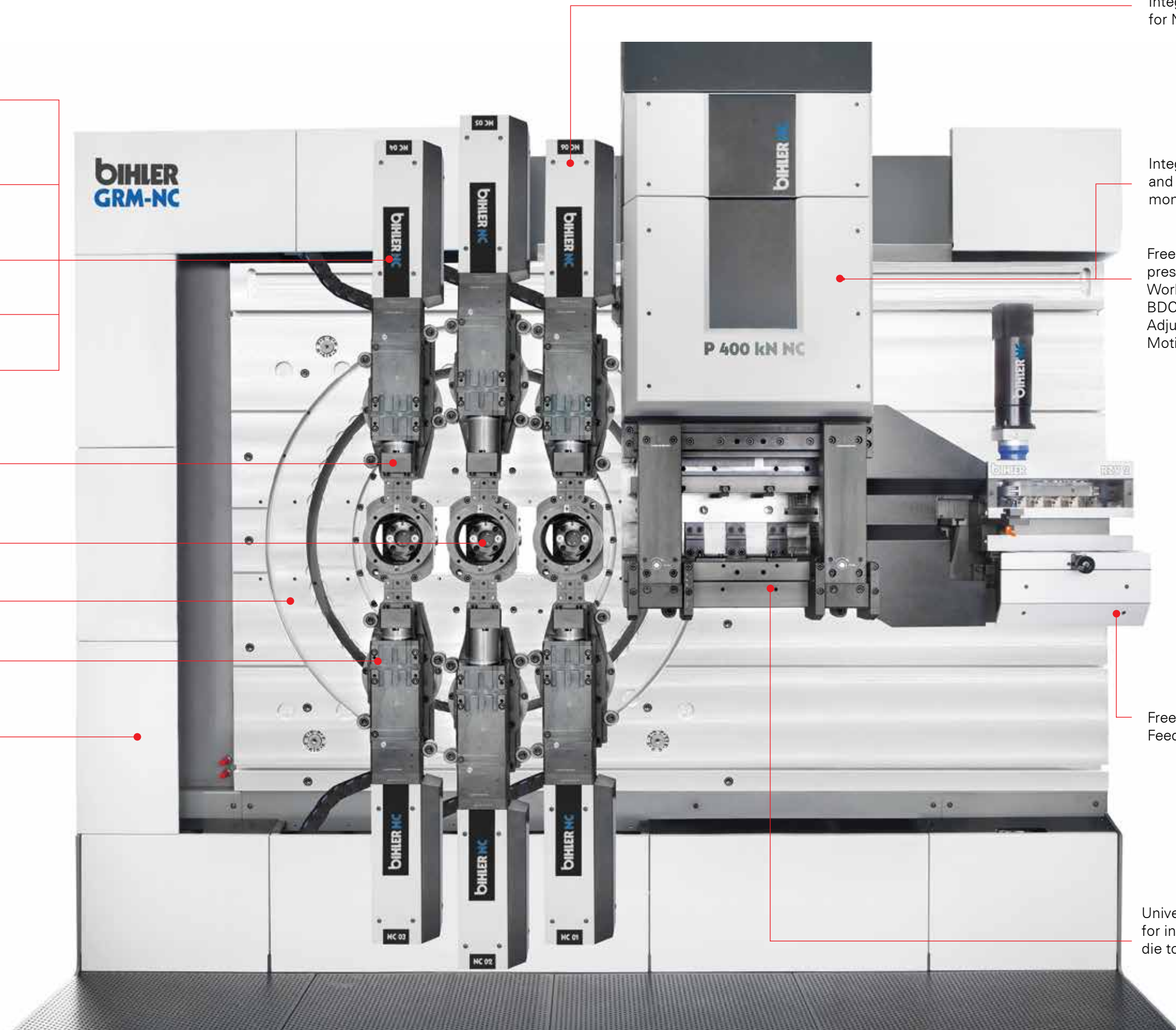

# RM-NC / GRM-NC

Alignment and positioning unit

## Fast and reproducible positioning

The RM-NC and GRM-NC have a fully automatic alignment and positioning unit in the machine corpus. It allows the positions of the NC slide modules to be adjusted radially and linearly simply by pressing a button. Once the slide positions have been set up they can be stored in the tool program. When the positions are retrieved or after a tool change, all positions are stored or can be restored for absolute reproducibility.

## Accurate assigning

The alignment and positioning unit is capable of moving the NC slide units to all basic positions as well as of assigning them to all corresponding slide models (narrow and standard slides, right/left versions) of RM and GRM machines.





# RM-NC / GRM-NC

Presses



## Servo two-point eccentric press RM-NC

- Nominal force 200 kN
- Fixed stroke with B.D.C.
- Integrated press force and bearing temperature monitoring
- Pre-tensioned press housing
- Installation space for dies 368 mm x 202 mm x 126 mm (LxWxH)



## Servo friction press GRM-NC

- Nominal force 400 kN
- Freely programmable stroke and stroke position adjustment
- No B.D.C., maximum press force possible at any time
- Integrated press force and bearing temperature monitoring
- Installation space for dies 670 mm x 207 mm x max. 250 mm (LxWxH)

# RM-NC / GRM-NC

Slide units / feed / central mandrel

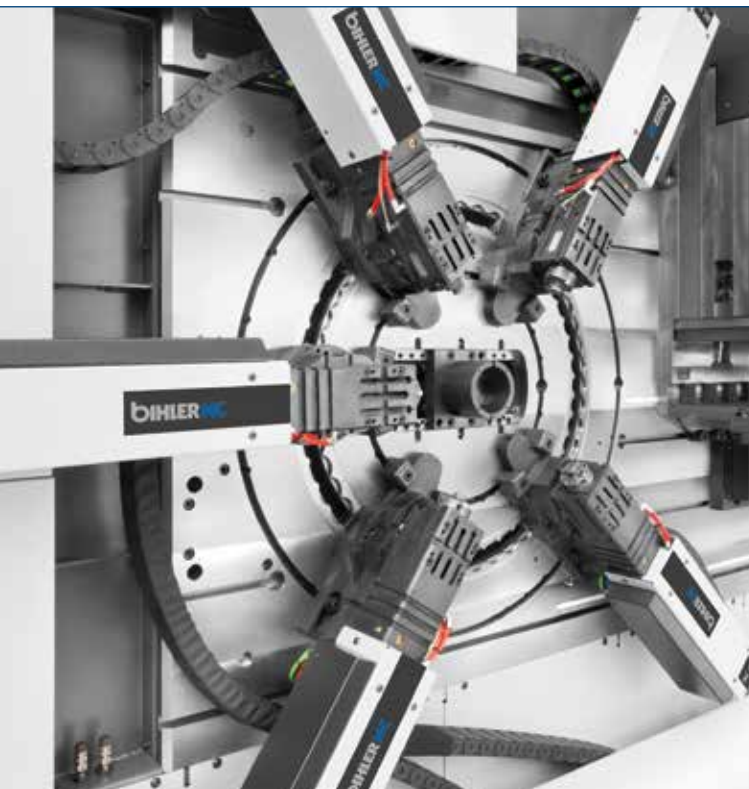

Slide units RM-NC

## Maximum processing freedom

All processing units are NC-controlled and are freely programmable over the whole working range. Working stroke, lower dead center, adjustment of the stroke position and the motion profile can be selected freely. Maximum output can be achieved at any time and with any stroke position. Forming motion can be implemented with constant power transmission.

Adjustments during tool changes are carried out via the program and do not require any mechanical add-ons.

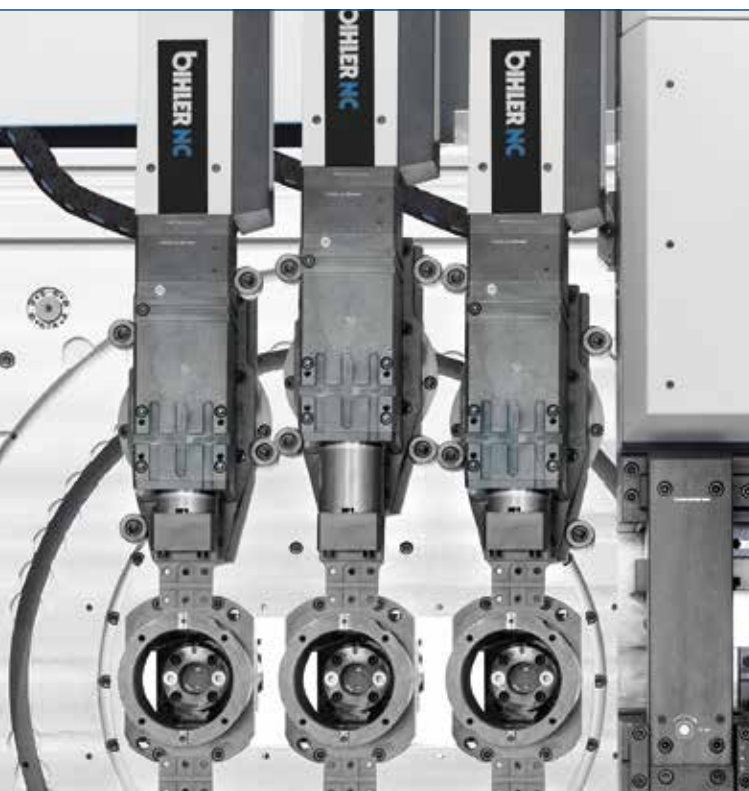

Slide units GRM-NC

## Highest process reliability

All compact units have an integrated cooling and central lubrication system. An overload safety device integrated in the software prevents incorrect handling or overloading of components. Units are fitted with an integrated absolute measuring system, enabling operation without overruns. Therefore process-related thermal effects are fully compensated.

## Slide units

NC slide units can be arranged in a radial or linear concept.

## Press

Two presses can be mounted on the machines. Universal press plate for integration of new and existing die tools.



Feed

## Feed

The compact radial gripper form feed RZV 2 impresses with high feed speeds and excellent positioning accuracy. Variable feed lengths from zero to infinity as well as various feeder lengths and movements (forwards and backwards) in one working cycle are possible. Accurate movement of material is ensured even for thickness tolerances.



Central mandrel

## Central mandrel

Large opening in the machine plate for integration of central mandrels (up to 3-fold version) in tool solutions.



# RM-NC / GRM-NC

Tool compatibility

## Tool compatibility with RM series and GRM series

When the number of product variations rises and the size of batches drops, production with a servo system offers significant advantages over mechanically driven stamping and forming machines. Therefore the RM-NC and GRM-NC are fully compatible with tools in the RM and GRM series. All tools from these machines can be easily adapted and optimized for these servo systems.

All interfaces for machine, press and processing units are given. The press disposes of a universal press plate for the integration of existing dies; slides dispose of a laterally movable tool plate carrier (standard) for mounting existing forming tools.

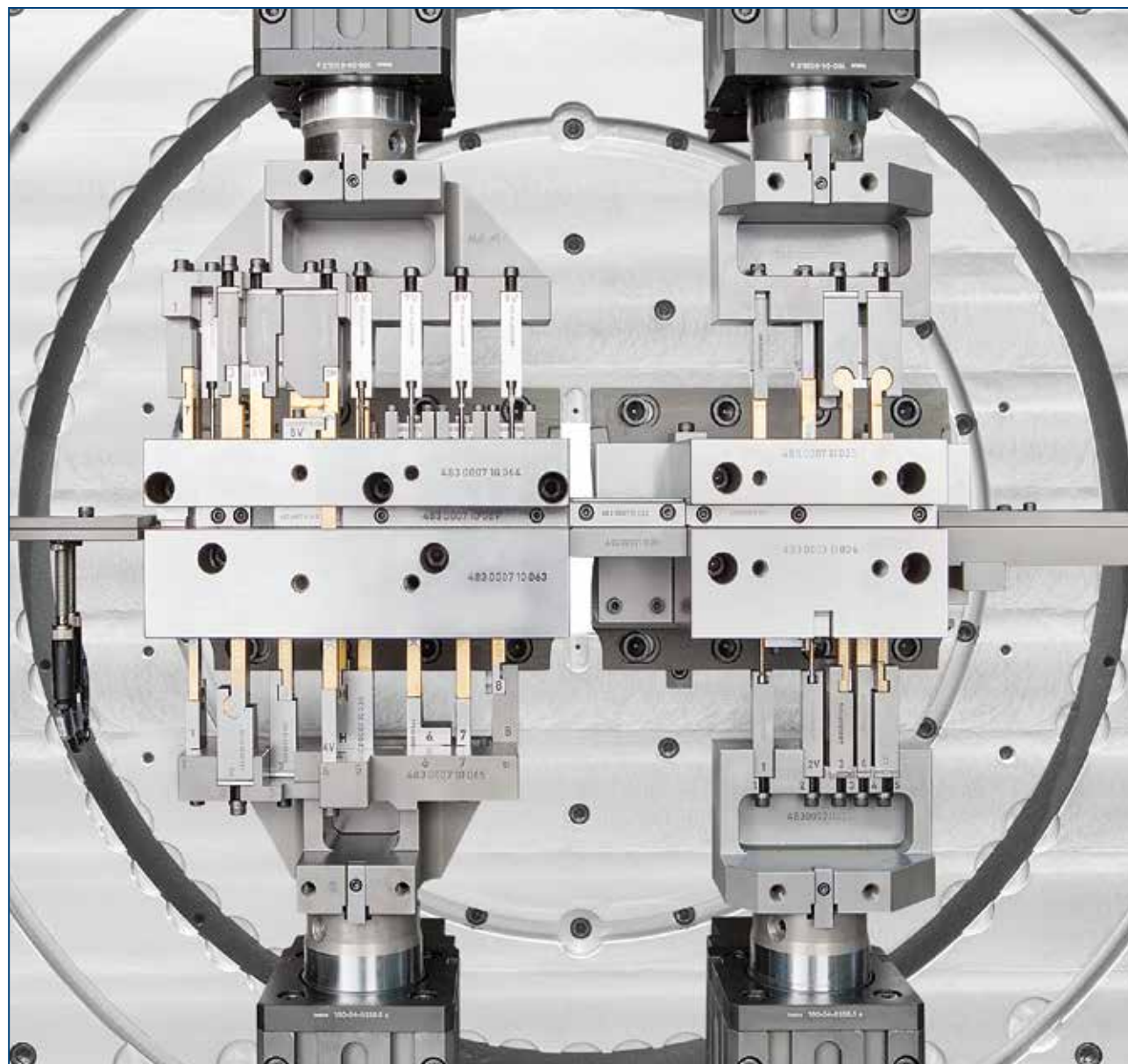

# MORE EFFICIENT MORE PRODUCTIVE MORE FLEXIBLE

## Technical data RM-NC (GRM-NC)

	min.	max.	
Number of slides	0	14 (12)*	*standard (>12: additional axis cabinet)
Nominal force (kN)		20 (40)	
Stroke (mm)	0	120 (100)	
Number of central mandrels		3 (3)	
Nominal force (kN)		40 (40)	
Stroke (mm)	0	100 (100)	
Servo two-point eccentric press			standard RM-NC
Nominal force (kN)		200 (300)	(300 kN press as option on GRM-NC)
Stroke (mm)	0	12	
Servo friction press			standard GRM-NC
Nominal force (kN)		(400)	
Stroke (mm)	0	(60)	
Numbers of strokes stepless** (1/min.)	0	300 (240)	**depending on tooling concept and max. press forces resp. nominal forces of slide units
Dimension (WxDxH, mm) without noise protection cabinet	3050 (3282) x 1820 x 2540 (2740) without press / 2600 (3055) with press		
Weight (kg)	approx. 6000 (9500) without tooling		

# VC 1

Machine and process control

## Highlights of the control system

- Easy, flexible machine setup without external programming device
- Customized menu-driven entry for fast setup and retooling
- Multi-media diagnostics and online help system bASSIST
- Freely configurable, individually adaptable production menus and user interfaces
- Integrated recording of measurement and production data
- Remote maintenance (optional) - First class support at the touch of a button

## Easy handling

The central machine and process control unit VariControl VC 1 supports the operator like a second operator on the machine. The machine is operated via a swivel terminal with touchscreen and other operating elements. The switching cabinet and the actuator are fully integrated in the machine casing of the RM-NC/GRM-NC.

## Direct programming

NC processing units are programmed directly via simple input screens.

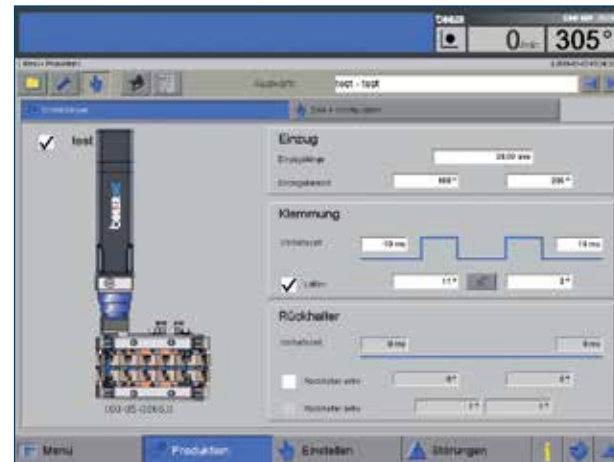

## Cam diagram optimization

Individual and easy optimization of travel profiles for higher productivity.

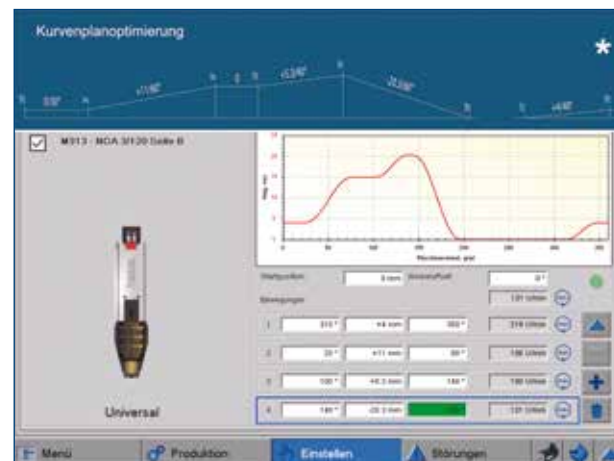

# MANUFACTURE SMALL BATCH SIZES MORE EFFICIENTLY

More than 300% increase in output possible\*

Extremely short set-up times (up to 9 times faster setup\*)



Servo stamping and forming machine with integrated operator protection

\*Production tests: Moving tools from mechanical machine types to servo machines.



**Otto Bihler Maschinenfabrik GmbH & Co. KG**

Lechbrucker Str. 15

D-87642 Halblech

Tel.: +49(0)8368/18-0

Fax: +49(0)8368/18-105

[info@bihler.de](mailto:info@bihler.de)

[www.bihler.de](http://www.bihler.de)